

Assemble the Lift Rod as shown, Nylon Bearing first then the Rod and finally the Rod Nut.

Insert the Pop-Up Rod in the Spout.

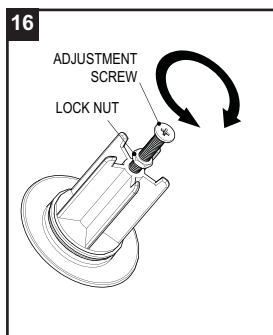
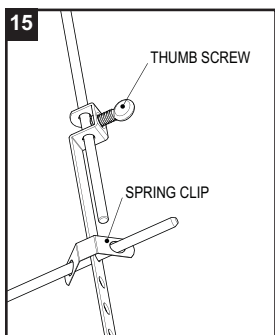

Push the Lift Rod down to the **Open Drain Position**. Connect the Pop-Up Rod to the Extension Ladder as shown using the Spring Clip and Thumb Screw to secure both pieces together.

Insert the Drain Plug into the sink. With the Pop-Up Rod all the way down the drain should be open. To close it, lift the Pop-Up Rod. The Drain Plug works on gravity and has an adjustment screw. Loosen the Lock Nut to make any adjustment required then re-tighten the Lock Nut to maintain the adjustment.

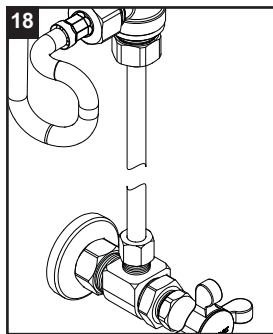
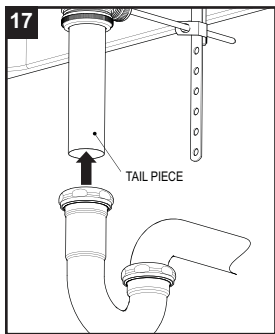

Hook up the 'P' Trap to the Drain Tail Piece.

Finally, connect the water supply from the Shut-Off valves (not supplied) to the bottom of the Sidebodies.

Remove the Aerator from the spout and flush the system to clear any debris that might have accumulated and replace the aerator.

TWO HANDLE WIDESPREAD LAVATORY SET

MODEL 1ARBFC or L

If you need assistance with installation, replacement parts or have any questions regarding your Rubinet product, please call a Customer service representative at: 905-851-6781 toll free 1-800-461-5901 or visit www.rubinet.com

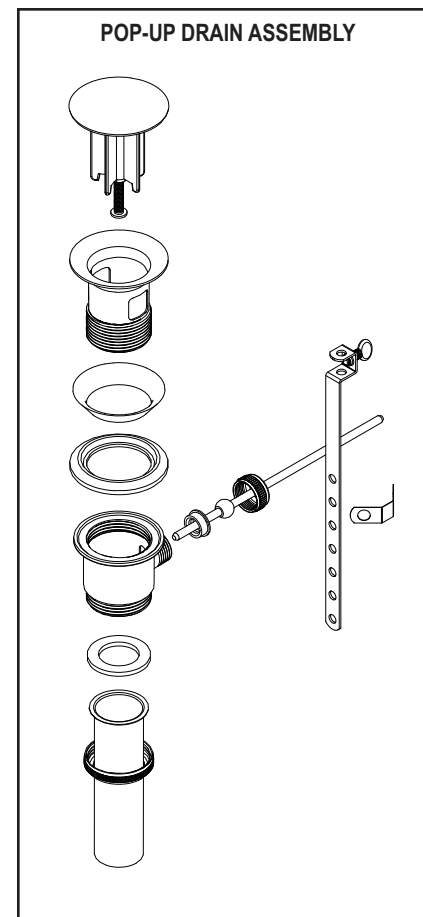
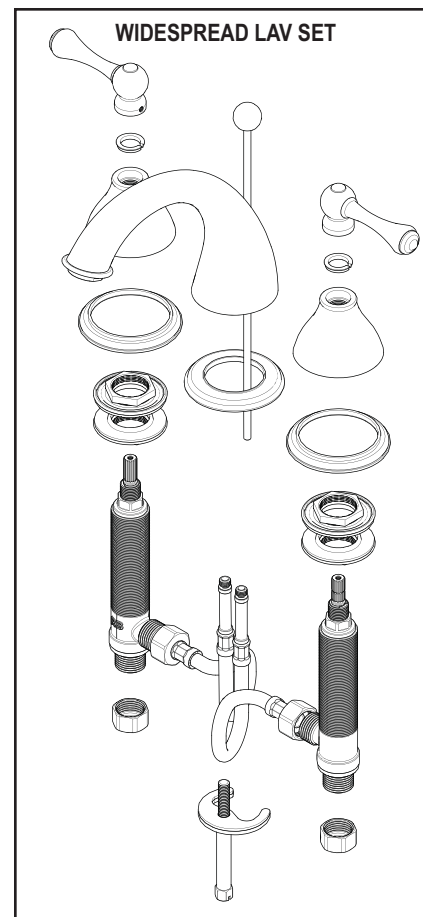
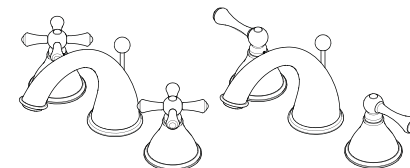

REMOVAL OF FAUCET:

Always turn the water supply **off** before removing the existing faucet or disassembling a valve. Open both faucet handles to relieve water pressure and to ensure that the water has been successfully turned off.

CARE OF FAUCET:

The use of warm water and a soft cloth is all that is required to clean Rubinet products. The patina of our living finishes (Oil Rubbed Bronze & Tuscan Brass) will change as a result of normal use. Applying Mineral Oil on occasion will create a softer look, subtle color changes and character.

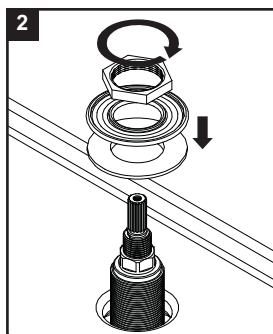
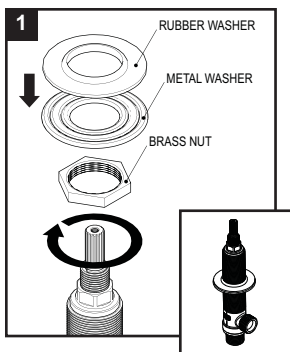

From the Mounting Kit, assemble one Brass Nut, one Metal Washer and one Rubber Washer to each Sidebody as shown.

Mount each Sidebody (**HOT on the left COLD on the right**) from under the sink/deck and assemble another Rubber Washer Metal Washer and Nut, to the top side of each Sidebody.

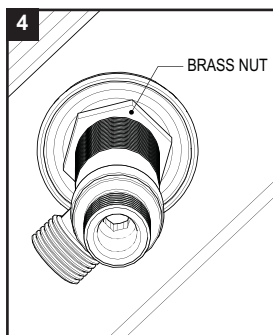
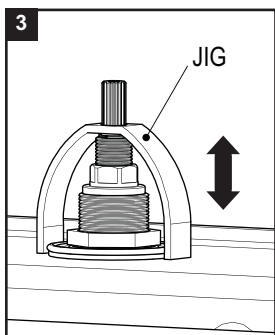

Next using the Jig provided, adjust the top side Brass Nut so that the correct sidebody height is achieved.

Tighten the Brass Nut on the underside of the sink/deck to secure each sidebody.

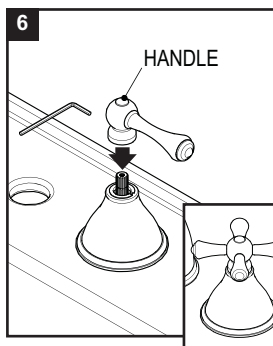
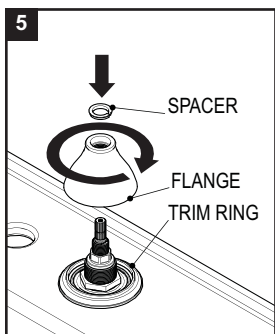

Place the Trim Rings as shown and screw both Flanges to the Sidebodies.

Install the small Teflon Spacer atop each flange before attaching the Handles.

Turn each valve off and position each Handle as required before tightening the Set Screw using the Allen Key provided.

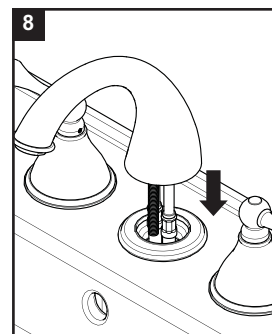
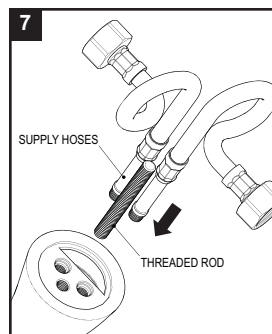

To the bottom of the Spout assemble both Supply Hoses (**HAND TIGHTEN ONLY**) and the Threaded Rod from the Spout Mounting Kit.

Place the Spout Trim Ring over the centre hole and assemble the Spout as shown.

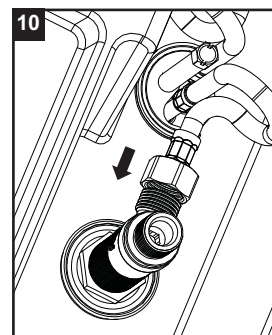
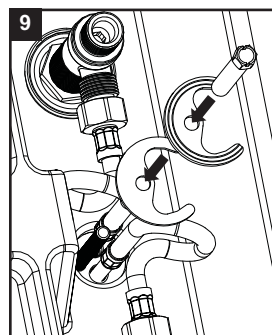

From the underside of the sink/deck assemble the remaining parts of the Spout Mounting Kit to the Threaded Rod. Rubber Washer first then the Metal Washer and finally the Tie Down Screw to secure the spout.

Attach each Supply Hose to the corresponding Sidebody. **Do not over tighten.**

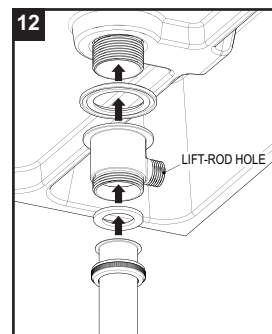
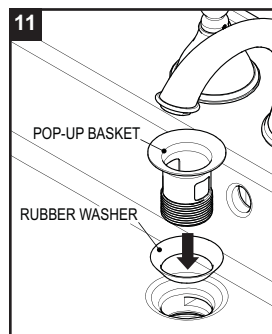

Insert the Pop-Up Basket and Rubber Washer as shown in the sink. Plumbers putty can be used instead of the Rubber Washer if preferred.

Assemble the remaining Pop-Up parts under the sink in the order shown, making sure that the Lift-Rod Hole is facing the back of the sink.