

DECK MOUNT TUB FILLER WITH HAND HELD SHOWER
MODEL 3DRBHXC or L

If you need assistance with installation, replacement parts or have any questions regarding your Rubinet product, please call a Customer service representative at: 905-851-6781 toll free 1-800-461-5901 or visit www.rubinet.com

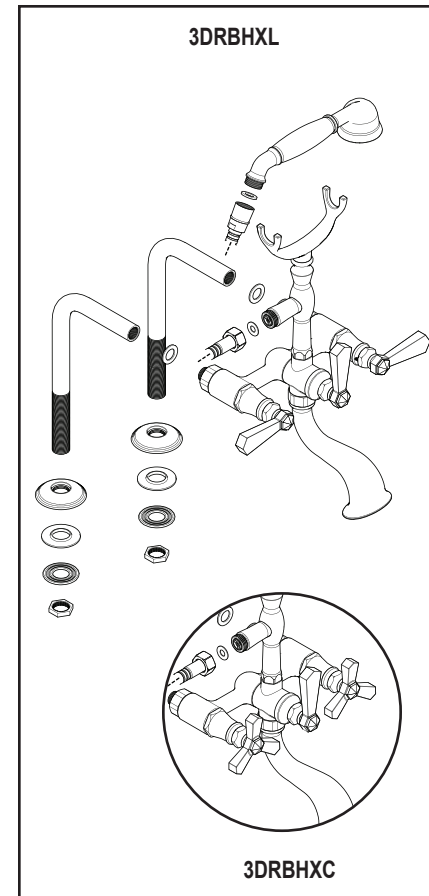
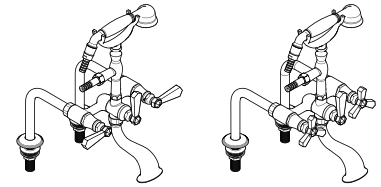

IMPORTANT:

Observe all local plumbing and building codes.

Shut-Off the main water supply.

REMOVAL OF FAUCET:

Always turn the water supply off before removing the existing faucet or disassembling a valve. Open both faucet handles to relieve water pressure and to ensure that the water has been successfully turned off.

CARE OF FAUCET:

The use of warm water and a soft cloth is all that is required to clean Rubinet products. The patina of our living finishes (Oil Rubbed Bronze & Tuscan Brass) will change as a result of normal use. Applying Mineral Oil on occasion will create a softer look, subtle color changes and character.

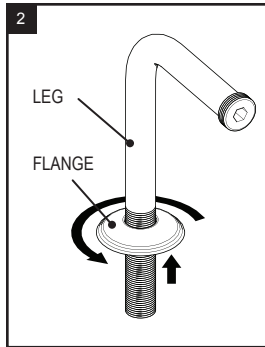
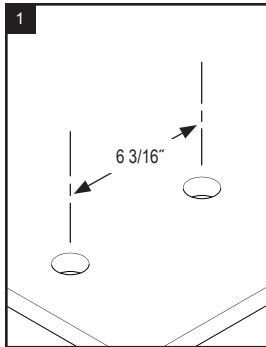

Drill holes 6 3/16" apart aligned where you wish to position the faucet.

Screw each flange on to the legs as far as they will go.

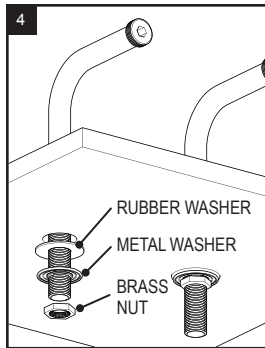
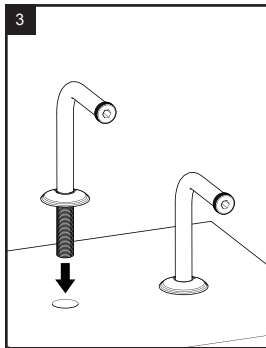

Position the legs in the two holes.

And secure from under the deck using the Rubber Washer then the Metal Washer and finally the Brass Nut.

Leave them loose enough to adjust the position of the Faucet Body.

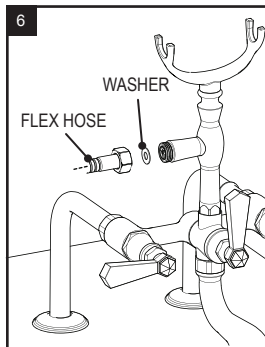
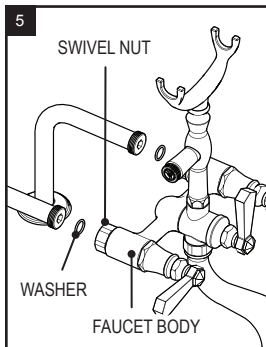

Insert a 3/4" Washer in each Swivel Nut and then Assemble the Faucet Body. Do not over tighten the Swivel Nuts

Attach the Flex Hose to the Faucet Body as shown.

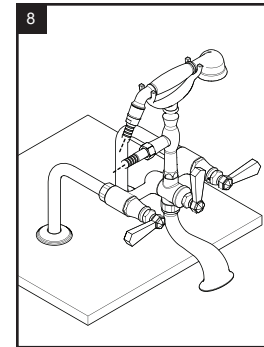
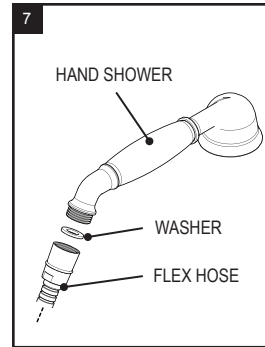

Attach the other end of Flex Hose to the Hand Shower.

Rest the Hand Shower on the Cradle as shown and turn on water to check for leaks.